

## / Product type

Press fittings for domestic gas supply systems.

## / Description

SEMPIGAS press fittings for multi-layer pipes are designed for use in domestic gas supply systems. SEMPIGAS press fittings differ from traditional products of this kind because they are implemented applying precautions that safeguard the health of users. This is done through a careful selection of the materials and processing operations aimed at keeping potentially dangerous substances from being released in potable water.

SEMPIGAS press fittings are easy to install. The materials used to make SEMPIGAS fittings comply with the strictest standards of safety applied to materials that come into contact with water used for human consumption. Used in combination with multi-layer pipes, SEMPIGAS fittings constitute a **SAFE, FAST and COST-EFFECTIVE** press system.

SEMPIGAS system is certified UNI 11344:2014.



## / Press system

SEMPIGAS press fittings are designed for installation making use of the radial pressing method. This type of joint has become increasingly popular as a result of the simplicity and speed with which it is installed. The fitting is also perfectly water-tight, even when subjected to high pressures and temperatures.

The clamp, made specifically to fit any diameter size of the multi-layer pipes utilized, presses against the stainless-steel bearing that secures the pipe to the fitting.

The mechanical seal is ensured by the particular body gauge of the fitting and by the relative steel bearing, which have been designed for pressing with three different clamp gauges; **these gauges are: TH.**

The wet seal is ensured by two O-rings.

After pressing, SEMPIGAS fittings form a connection between the pipe and fitting so as to provide maximum stability and wear.

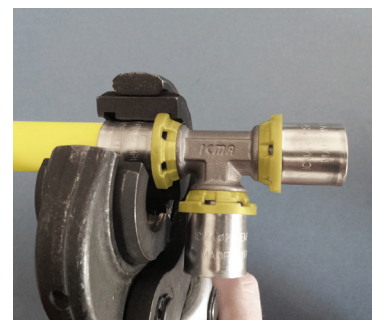

## / Product range

Series	Items	Connections	Multilayer Pipe Size (Diameter x Thickness)				Page
			16x2	20x2	25x2,5	26x3	
450	Straight Fitting	Simple and reduced	16x2	20x2	25x2,5	26x3	5
451	Straight Fitting	Female	16x2	20x2	25x2,5	26x3	5
452	Straight Fitting	Male	16x2	20x2	25x2,5	26x3	5
453	Angled Fitting	Simple	16x2	20x2	25x2,5	26x3	6
454	Angled Fitting	Male	16x2	20x2	25x2,5	26x3	6
455	Angled Fitting	Female	16x2	20x2	25x2,5	26x3	6
456	"T" Fitting	Simple and reduced	16x2	20x2	25x2,5	26x3	6
458	"T" Fitting	Female	16x2	20x2	25x2,5	26x3	7
459	Wall fitting	G1/2" Female	16x2	20x2			7
460	Revolving Nut Fitting	Flat seat derivation	16x2	20x2			8
461	Drilled by plumbing	Gas meter fitting	16x2	20x2	25x2,5		8
462	Air release valve	Gas meter fitting	16x2	20x2	25x2,5		8
463	Pressure check valve	Gas meter fitting	16x2	20x2	25x2,5		8
464	Angled, Drilled by plumbing	Gas meter fitting	16x2	20x2	25x2,5		9
465	Angled, Air release valve	Gas meter fitting	16x2	20x2	25x2,5		9
466	Angled, Pressure check valve	Gas meter fitting	16x2	20x2	25x2,5		9

## / Technical characteristics

Pressing clamp gauges:	TH
Gas to be used:	Methane and GPL
Maximum operating temperature:	70°C
Minimum operating temperature:	-20°C
Maximum operating pressure:	0,5 bar

## / Materials

<b>1) Body:</b>	CW617N Brass - UNI EN 12165 with surface treatment
<b>2) Bearing:</b>	STAINLESS Steel - AISI 304 with hardening treatment
<b>3) Ring nut:</b>	Nylon 6 - Yellow colored
<b>4) O-Ring:</b>	HNBR70 Yellow

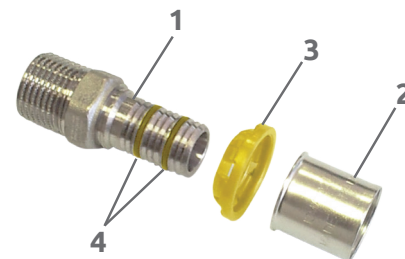

## / Design details

**1) BODY** – All the brass body parts of the SEMPIGAS fittings undergo surface treatments.

**2) BEARING** – The bearings are made of stainless steel and undergo a hardening process that makes them particularly resistant to the effects of alkali contained in cement and to those of anhydride plaster. Engraved on each bearing is the size of the multi-layer pipe with which it is to be used. The bearings are hooked on to the body through a ring nut coupling.

**3) RING NUTS** – The nylon ring nuts perform four important functions, they:

- keep bearings connected to the fitting;
- make it possible to check that the pipe has been correctly inserted in the fitting before proceeding with the pressing stage. The pipe must be inserted in the fitting as far as possible and must be visible through the ring nut slots;
- function as guides for correct positioning of jaws during pressing;
- create a dielectric coating between the aluminum portion of the multilayer pipe and the brass body, thus preventing corrosion.

**4) O-RING** – The O-Rings mounted on all the fittings of the SEMPIGAS series are made of yellow HNBR70 material, that is certified for use in pipes that come into contact with gas; they are mounted on the fittings without using any grease. The O-Rings utilized are completely free of defects and are tested by applying the same rules that regulate the automotive sector; final checks to verify the correct mounting of O-rings is performed on 100% of the fittings produced.

The SEMPIGAS series of fittings provides that the fitting **LEAKS IF NOT PRESSED**. This condition exists in order to prevent possible errors caused by distraction during installation, resulting in additional fixing times and costs. This is made possible thanks to precision machining.

## / What surface treatment do our brasses undergo?

All the brass body parts of the SEMPIGAS fittings undergo surface treatments.

The treatment creates a uniform surface coating throughout all the fitting surfaces, both the external and internal surfaces, and covers even the most internal areas of the fitting.

The coating gives the external surfaces of the fittings good surface hardness making them resistant to the corrosive effects of the additives contained in the tail-in slurry. This is why they are especially suitable for trace heater installations.

The treatment reduces the surface roughness of the internal surfaces of fittings, which guarantees lower load losses and prevents limestone deposits. The surface treatment also makes fittings completely non-toxic: brass, generally utilized to manufacture fittings for water supply systems, contains small amounts of lead, zinc and arsenic (even if only in small amounts); these are harmful to human health. The surface treatment keeps these elements from being released in the water when the pipes are used to carry water for human consumption.

The surface treatment provides a permanent guarantee of quality. Ageing tests performed in the laboratory have shown that the treated brass does not peel and does not deteriorate over time.

*The fittings treated observe the limits set by current international regulations.*

## / Installation

SEMPIGAS fittings can be pressed making use of electrical or battery-driven pressing machines with jaws or inserts that apply one of the following gauges: **TH**.

To ensure correct pressing, make sure that the pressing machine is in good condition and that it functions perfectly, according to manufacturer specifications.

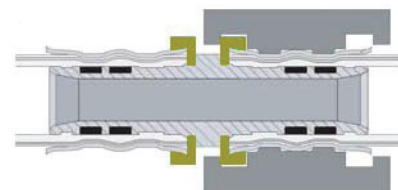

**PROFILE TH**

The above figures indicate the gauge of the fitting pressed with the TH jaw. The different position of the jaws on the steel bearings are clearly noticeable as compared to the plastic ring nuts.

## / Pressing operations



**1) Cut**

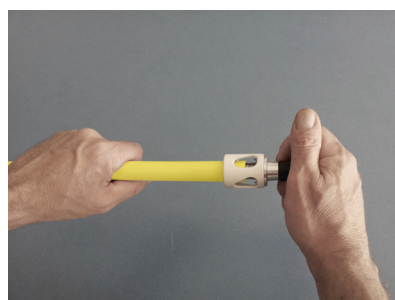

**2) Calibrate**



**3) Insert**



**4) Press**

## / Description of pressing operations

**1) CUT** – Cut the pipe making use of appropriate shears. The cut should be perpendicular to the pipe axis for correct pressing.

**2) CALIBRATE** – Calibrate and trim the pipe using the appropriate tool. This operation is performed to prepare the pipe for insertion inside the fitting. Calibration serves to straighten the pipe in case it has been warped, even slightly, during cutting. The trimming operation makes it easier to insert the fitting without damaging the O-rings.

**3) INSERT** – Insert the pipe inside the fitting as far as possible. The pipe has been correctly inserted if the end portion is visible through the slots on the plastic ring nuts.

**4) PRESS** – SEMPIGAS fittings can be pressed making use of jaws or inserts that have one of the following gauges: TH. Place the press jaws at the end of the fitting to be pressed, as shown in the above diagrams. The TH type jaw should be placed so that the plastic ring nut fits into the appropriate slot located on the same jaw section.

The fitting is correctly blocked only when the clamps are completely closed. Once the pressing operation has been completed, always check that the pipe is correctly positioned through the slots on the plastic ring nut.

If pressing has not been performed correctly, it is necessary to cut the pipe and repeat the operation applying a new fitting.

## / Leaks if not pressed

The SEMPIGAS series of fittings provides that the fitting LEAKS IF NOT PRESSED. It has been conceived this way so as to prevent errors from occurring through carelessness, during installation, possibly resulting in the need to perform additional costly, time consuming operations. Checks to ensure that fittings have been correctly pressed should be carried out each time an installation, or even a part of an installation, is implemented, to avoid wasting time needlessly after the installation has been completed.

*To verify that the fittings installed have been correctly pressed, simply fill the system with water and apply pressure; even low pressure values are sufficient for this purpose. This test should never exceed 0,5 bar.*

## / Product certification

CERTIFICATE

Numero KIP-078495/03  
Emesso 04.03.2020  
Rapporto 130100797

Sostituisce KIP-078495/02  
Prima emissione 25.06.2013  
Contratto K10-14  
Pagina 1 di 1

**CERTIFICATO DI PRODOTTO KIWA-UNI**  
**PRODUCT CERTIFICATE KIWA-UNI**

Kiwa Cermet Italia dichiara che i prodotti  
*Kiwa Cermet Italia hereby declare that the products*

**Sistemi di tubazioni multistrato metallo plastiche e raccordi per installazione interna per il trasporto del gas**  
*Metal-plastic multilayer piping systems and fittings for indoor installation for the conveyance of gaseous fuels*

Marchio del sistema/System Trade mark: **icma Sempigas**

Diametro e spessore di parete <i>Nominal DN and wall thickness</i>	Strati <i>Layers Material</i>	Tipo <i>Type</i>	Raccordi <i>Fittings</i>
DN 16x2,0 A10,40	PE-Xc/Al/Pe-Xb	MOP 0,5GAS	Brass press fittings profile TH
DN 20x2,0 A10,50	PE-Xc/Al/Pe-Xb	MOP 0,5GAS	Brass press fittings profile TH
DN 26x3,0 A10,60	PE-Xc/Al/Pe-Xb	MOP 0,5GAS	Brass press fittings profile TH

Sistema Costruito da/System Manufactured by: **icma S.p.A. Cuggiono (MI), Italia**

In base ai test di tipo nonché alle ispezioni periodiche condotte da Kiwa sono ritenuti conformi ai requisiti del **Documento Tecnico Ki-0410 Rev. 11, Annex K10 Rev. 01** basato sulla normativa **UNI 11344:2016** e quindi marchiati **Kiwa-UNI**. La validità di questo certificato è soggetta al risultato positivo delle sorveglianze periodiche.

*Based upon type tests and on Kiwa's periodic factory inspections the products are considered in compliance with the requirement of **Technical Document Ki-0410, Rev. 11, Annex K10 Rev. 01**, based on the standard **UNI 11344:2016** and consequentially marked **Kiwa-UNI**. The validity of this certificate is subject to the positive result of periodic surveillance visits*

**Il presente certificato viene rilasciato in accordo al Regolamento Kiwa Cermet Italia per la Certificazione di prodotto ed è composto da 1 pagina.**

*This certificate is issued in accordance with the Kiwa Cermet Italia regulations for Product Certification and consists of 1 page*

**Chief Operating Officer**  
*Giampiero Belcredi*

**kiwa**

**IT-TD-Ki0410**

PRD N° 0698

**Kiwa Cermet Italia S.p.A.**  
Società con socio unico, soggetta all'attività di direzione e coordinamento di Kiwa Italia Holding Srl  
Via Cadrano, 23  
40057 Granarolo dell'Emilia (BO)

**Unità secondaria**  
Via Treviso 32/34  
31020 San Vendemiano (TV)  
Tel +39 0423 417165  
Fax +39 0423 22428  
E-mail: [info@kiwacermet.it](mailto:info@kiwacermet.it)  
[www.kiwa.it](http://www.kiwa.it)  
[www.kiwacermet.it](http://www.kiwacermet.it)

## / Codes and dimensions

### Series 450

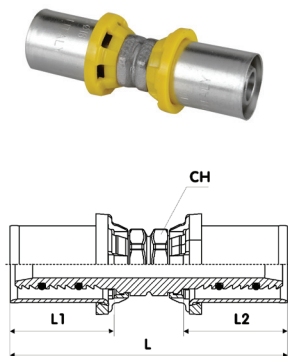

PIPE SIZE		Straight fitting				CH	CODE
		L	L1	L2			
16x2	16x2	66	25	25	15	81450GH06	
20x2	20x2	67	25	25	20	81450BQ06	
25x2,5	25x2,5	70	25	25	23	81450GO06	
26x3	26x3	70	25	25	23	81450GP06	
32x3	32x3	68	25	25	29	81450GQ06	
16x2	20x2	67	25	25	20	81450BQGH06	
20x2	26x3	68	25	25	23	81450GPBQ06	
25x2,5	20x2	68	25	25	23	81450GOBQ06	
32x3	25x2,5	69	25	25	29	81450GQGO06	

### Series 451

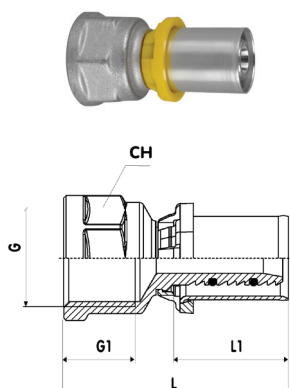

PIPE SIZE		L	L1	G	G1	CH	CODE
16x2	1/2"	49	25	1/2"	16	24	81451ADGH06
20x2	1/2"	48	25	1/2"	16	24	81451ADBQ06
20x2	3/4"	51	25	3/4"	17	31	81451AEBQ06
25x2,5	3/4"	55	25	3/4"	17	31	81451AEGO06
26x3	3/4"	51	25	3/4"	17	31	81451AEGP06
25x2,5	1"	55	25	1"	18	38	81451AFGO06
32x3	1"	52	25	1"	18	38	81451AFGQ06

### Series 452

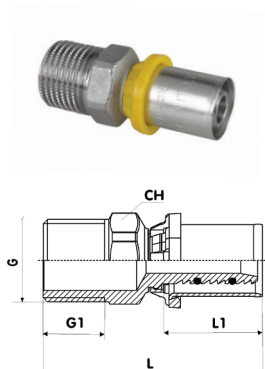

PIPE SIZE		L	L1	G	G1	CH	CODE
16x2	1/2" ●	55	25	1/2"	16	22	81452ADGH06
20x2	1/2" ●	54	25	1/2"	16	22	81452ADBQ06
20x2	3/4" ●	57	25	3/4"	17	27	81452AEBQ06
25x2,5	3/4" ●	57	25	3/4"	17	27	81452AEGO06
25x2,5	1"	61	25	1"	18	34	81452AFGO06
26x3	3/4" ●	57	25	3/4"	17	27	81452AEGP06
26x3	1"	61	25	1"	18	34	81452AFGP06
32x3	1"	59	25	1"	18	34	81452AFGQ06

● Conical thread ISO 7-1.

## Series 453

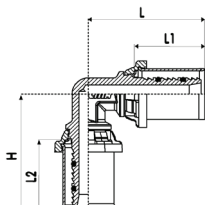

PIPE SIZE		Angled fitting				CODE
		L	L1	L2	H	
16x2	16x2	41	25	25	41	81453GH06
20x2	20x2	43	25	25	43	81453BQ06
25x2,5	25x2,5	47	25	25	47	81453GO06
26x3	26x3	47	25	25	47	81453GP06
32x3	32x3	49	25	25	49	81453GQ06

## Series 454

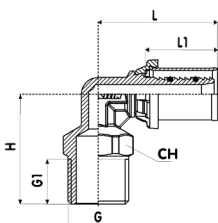

PIPE SIZE		Angled male fitting							CODE
		L	L1	H	G	G1	CH		
16x2	1/2" ●	41	25	38	1/2"	16	22	81454ADGH06	
20x2	1/2" ●	41	25	38	1/2"	16	22	81454ADBQ06	
20x2	3/4" ●	44	25	39	3/4"	17	27	81454AEBQ06	
25x2,5	3/4" ●	45	25	42	3/4"	17	27	81454AEGO06	
26x3	3/4" ●	45	25	42	3/4"	17	27	81454AEGP06	

● Conical thread ISO 7-1.

## Series 455

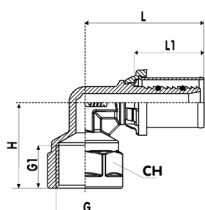

PIPE SIZE		Angled female fitting							CODE
		L	L1	H	G	G1	CH		
16x2	1/2"	45	25	25	1/2"	16	24	81455ADGH06	
20x2	1/2"	45	25	31	1/2"	16	24	81455ADBQ06	
20x2	3/4"	46	25	31	3/4"	17	31	81455AEBQ06	
25x2,5	3/4"	47	25	35	3/4"	17	31	81455AEGO06	
26x3	3/4"	47	25	35	3/4"	17	31	81455AEGP06	

## Series 456

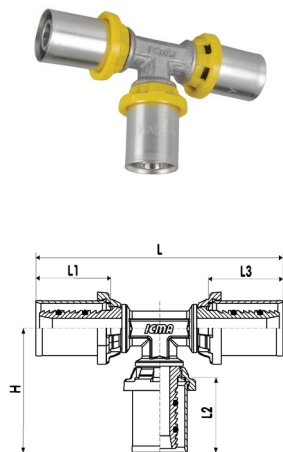

"T" fitting								
PIPE SIZE			L	L1	L2	L3	H	CODE
16x2	16x2	16x2	82	25	25	25	41	81456GH06
20x2	20x2	20x2	85	25	25	25	43	81456BQ06
26x3	26x3	26x3	94	25	25	25	47	81456GP06

Reduced or expanded centre "T" fitting								
PIPE SIZE			L	L1	L2	L3	H	CODE
16x2	16x2	20x2	85	25	25	25	43	81456GHGHBQ06
16x2	16x2	26x3	85	25	25	25	43	81456GHGHP06
20x2	16x2	20x2	85	25	25	25	43	81456BQGHQB06
20x2	20x2	16x2	85	25	25	25	43	81456BQBQGH06
20x2	20x2	26x3	91	25	25	25	46	81456BQBQGP06
25x2,5	16x2	25x2,5	94	25	25	25	46	81456GOGHGO06
25x2,5	20x2	20x2	91	25	25	25	46	81456GOBQBQ06
25x2,5	20x2	25x2,5	94	25	25	25	46	81456GOBQGO06
25x2,5	25x2,5	16x2	94	25	25	25	46	81456GOGOGH06
25x2,5	25x2,5	20x2	94	25	25	25	46	81456GOGOBQ06
26x3	16x2	26x3	94	25	25	25	46	81456GPGHGP06
26x3	20x2	26x3	94	25	25	25	46	81456GPBQGP06
32x3	25x2,5	25x2,5	98	25	25	25	49	81456GQGOGO06
32x3	25x2,5	32x3	98	25	25	25	50	81456GQGOGQ06

## Series 458

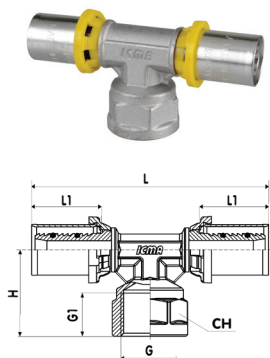

Female "T" fitting									
PIPE SIZE			L	L1	H	G	G1	CH	CODE
16x2	1/2"	16x2	85	25	31	1/2"	16	24	81458ADGH06
20x2	1/2"	20x2	85	25	31	1/2"	16	24	81458ADBQ06
20x2	3/4"	20x2	92	25	31	3/4"	17	31	81458AEBQ06
25x2,5	3/4"	25x2,5	95	25	35	3/4"	17	31	81458AEGO06
26x3	3/4"	26x3	95	25	35	3/4"	17	31	81458AEGP06

## Series 459

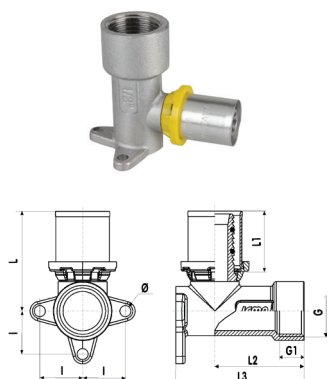

Wall fitting										
PIPE SIZE		L	L1	L2	L3	G	G1	I	Ø	CODE
16x2	1/2"	41	25	36	57	1/2"	16	17.5	4.5	81459ADGH06
20x2	1/2"	41	25	36	57	1/2"	16	17.5	4.5	81459ADBQ06

## Series 460

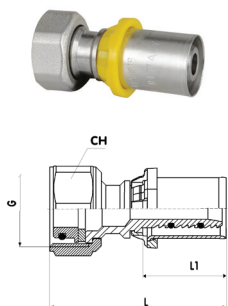

Flat seat derivation fitting						
PIPE SIZE		L	L1	G	CH	CODE
16x2	1/2"	50	25	1/2"	24	81460ADGH06
16x2	3/4"	50	25	3/4"	30	81460AEGH06
20x2	3/4"	50	25	3/4"	30	81460AEBQ06

## Series 461

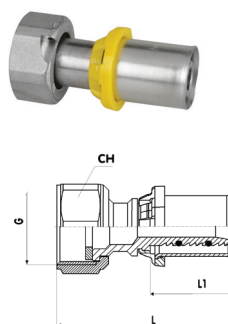

Fitting drilled for plumbing						
PIPE SIZE		L	L1	G	CH	CODE
16x2	1/2"	50	25	1/2"	24	81461ADGH06
16x2	3/4"	50	25	3/4"	30	81461AEGH06
20x2	1/2"	51	25	1/2"	25	81461ADBQ06
20x2	3/4"	50	25	3/4"	30	81461AEBQ06
25x2,5	3/4"	50	25	3/4"	30	81461AEGO06
20x2	7/8"	50	25	7/8"	34	81461AQBQ06
25x2,5	7/8"	50	25	7/8"	34	81461AQGO06
32x3	1"	60	28	1"	36	81461AFGQ06

## Series 462

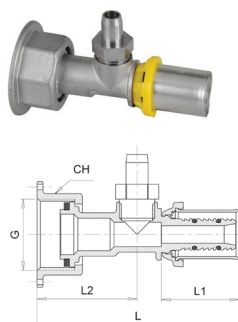

Fitting with air release valve							
PIPE SIZE		L	L1	L2	G	CH	CODE
16x2	1/2"	75	28	37,5	1/2"	24	81462ADGH06
20x2	1/2"	75	28,5	37,5	1/2"	24	81462ADBQ06
16x2	3/4"	75	29	37	3/4"	30	81462AEGH06
20x2	3/4"	75	31	37	3/4"	30	81462AEBQ06
20x2	7/8"	75	31	37	7/8"	34	81462AQBQ06
25x2,5	7/8"	82	38	37	7/8"	34	81462AQGO06
32x3	7/8"	78	25	41	7/8"	34	81462AQGQ06

## Series 463

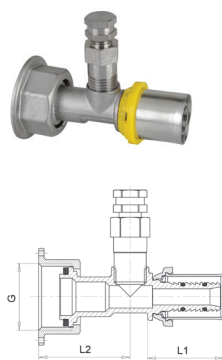

Fitting with pressure check port							
PIPE SIZE		L	L1	L2	G	CH	CODE
16x2	3/4"	75	29	37	3/4"	30	81463AEGH06
20x2	3/4"	75	31	37	3/4"	30	81463AEBQ06
20x2	7/8"	75	31	37	7/8"	34	81463AQBQ06
25x2,5	7/8"	82	38	37	7/8"	34	81463AQGO06

## Series 464

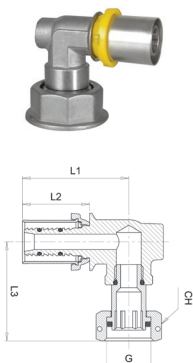

Angled fitting drilled for plumbing							
PIPE SIZE		L	L1	L2	G	CH	CODE
16x2	1/2"	45	28	41,5	1/2"	24	81464ADGH06
20x2	1/2"	45	28	41,5	1/2"	24	81464ADBQ06
16x2	3/4"	45	28	39,5	3/4"	30	81464AEGH06
20x2	3/4"	45	28	39,5	3/4"	30	81464AEBQ06
25x2,5	3/4"	46	30	39,5	3/4"	30	81464AEGO06

## Series 465

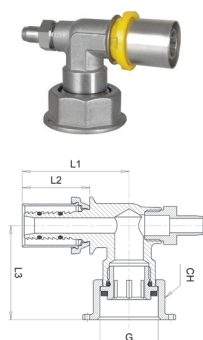

Angled fitting with release valve							
PIPE SIZE		L	L1	L2	G	CH	CODE
16x2	3/4"	45	28	39,5	3/4"	30	81465AEGH06
20x2	3/4"	45	28	39,5	3/4"	30	81465AEBQ06
20x2	7/8"	45	28	42	7/8"	34	81465AQBQ06
25x2,5	7/8"	46	29,5	42	7/8"	34	81465AQGO06

## Series 466

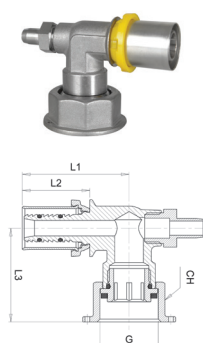

Angled fitting with pressure check port							
PIPE SIZE		L	L1	L2	G	CH	CODE
16x2	3/4"	45	28	39,5	3/4"	30	81466AEGH06
20x2	3/4"	45	28	39,5	3/4"	30	81466AEBQ06
20x2	7/8"	45	28	42	7/8"	34	81466AQBQ06
25x2,5	7/8"	46	29,5	42	7/8"	34	81466AQGO06